

RUE25-E

滚子单轨引导系统

带满装循环滚珠导引系统的标准滑块, 用于直线循环滚珠轴承和导轨组件, 用于油润滑或脂润滑

技术信息

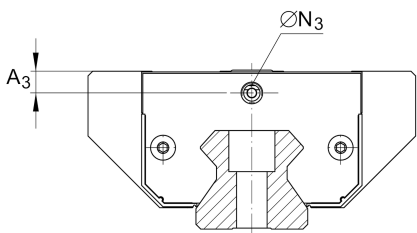
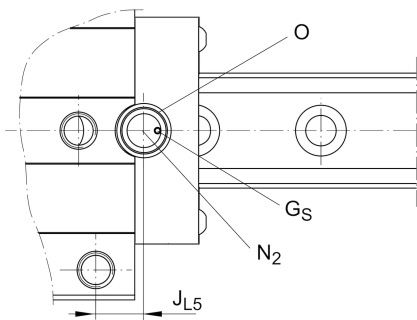
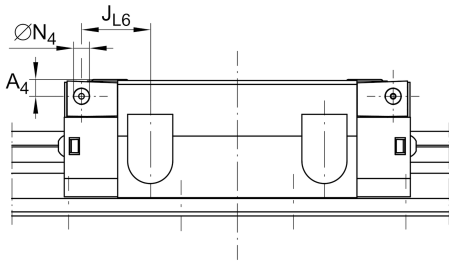
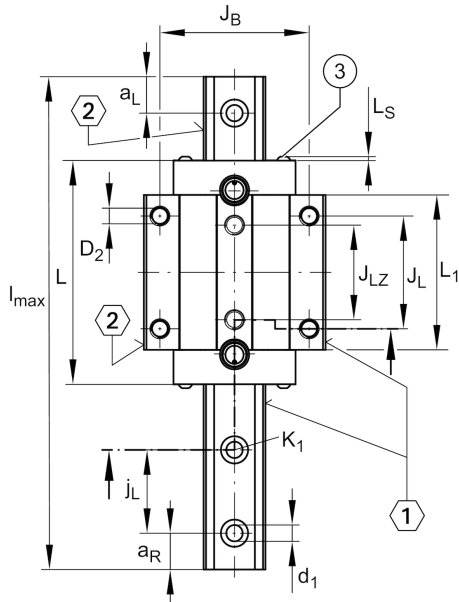
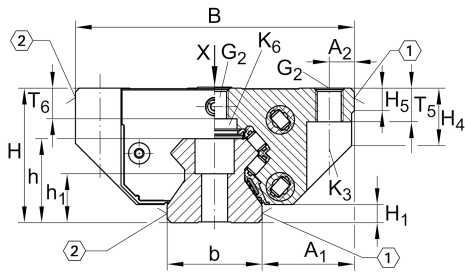

安装尺寸

A ₁	[23.5] mm	
J _B	[57] mm	
b	[23] mm	width rail
Tol _b	[-0.005] mm	Upper tolerance
Tol _b	[-0.03] mm	Lower tolerance
A ₂	[6.5] mm	
L ₁	[65.6] mm	
J _L	[45] mm	
J _{LZ}	[40] mm	
j _L	[30] mm	
a _{L min}	[20] mm	
a _{L max}	[23] mm	
a _{R min}	[20] mm	Distance
a _{R max}	[23] mm	
H ₁	[6.5] mm	
H ₄	[17.8] mm	
H ₅	[5.25] mm	
T ₅	[10] mm	
T ₆	[8.5] mm	
h	[22.3] mm	
h ₁	[11.8] mm	
G ₂	[M8]	fixing screws
G _{2MA}	[24] Nm	maximum tightening torque
K _{1MA}	[17] Nm	maximum tightening torque
K ₃	[M6]	fixing screws
K _{3MA}	[17] Nm	maximum tightening torque
K ₆	[M6]	fixing screws
K _{6MA}	[10] Nm	maximum tightening torque
d ₁	[6.7] mm	
D ₂	[6.7] mm	
A ₃	[7.5] mm	position lubrication adapter
N ₃	[M6]	lubrication connector
N _{2 max}	[3] mm	
J _{L5}	[14.5] mm	
G _S	[M4x4]	
O	[10x1,5]	O-Ring DIN 3771

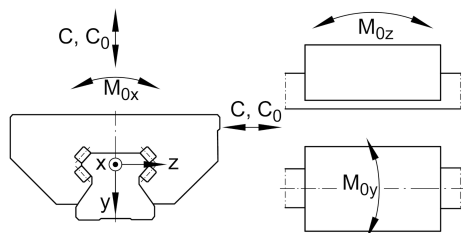
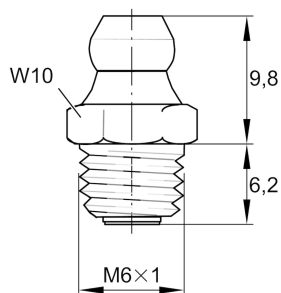

Main dimensions

l_{\max}	[3,930] mm	Max length single piece guideway
H	[36] mm	height system
B	[70] mm	width carriage
L	[91] mm	overall length carriage

Technical data

C	[28,000] N	dynamic load rating
C_0	[65,000] N	static load rating
M_{0x}	[350] Nm	static moment rating about X axis
M_{0y}	[760] Nm	static moment rating about Y axis
M_{0z}	[680] Nm	static moment rating about Z axis